



# TESTING TESTACAL

TEMPERATURE AND HUMIDITY TESTING CHAMBER  
SPECIALLY DESIGNED FOR CALIBRATION, METROLOGY  
AND QUALITY CONTROL





**ARALAB** is a company specialised in designing, developing, manufacturing and servicing of high quality climatic chambers and controlled environment rooms.

Since 1985 we have been perfecting ways to create and control temperature, humidity, light, air flow and many other environmental conditions.

Only the highest quality components are used to manufacture our chambers so customers can have the best equipment for their research and testing purposes.

**Control the environment, Your own climate.**



**Aralab Testing chambers have been the preferred solution of several ISO 17025 calibration laboratories and quality control institutions in Europe.**

**COMMON APPLICATIONS INCLUDE:**

- Metrology
- Calibration
- Quality Control
- Environmental Testing

**KEY FEATURES**

- The most advanced technology in climatic control
- Internal aerodynamic optimization that ensures highly uniform and stable climatic conditions
- Time saving features with easily configurable testing programs that can run, start and stop automatically
- Highly resistant stainless steel interior for maximum durability and easy cleaning
- Flexible interior with height adjustable and removable stainless steel shelves
- Non-polluting construction and cooling system
- Compliant with international standards and requirements EN, IEC, DIN, ISO, NP and UNE



Certified ISO:9001 for its Quality Management System

## TECHNICAL INFORMATION



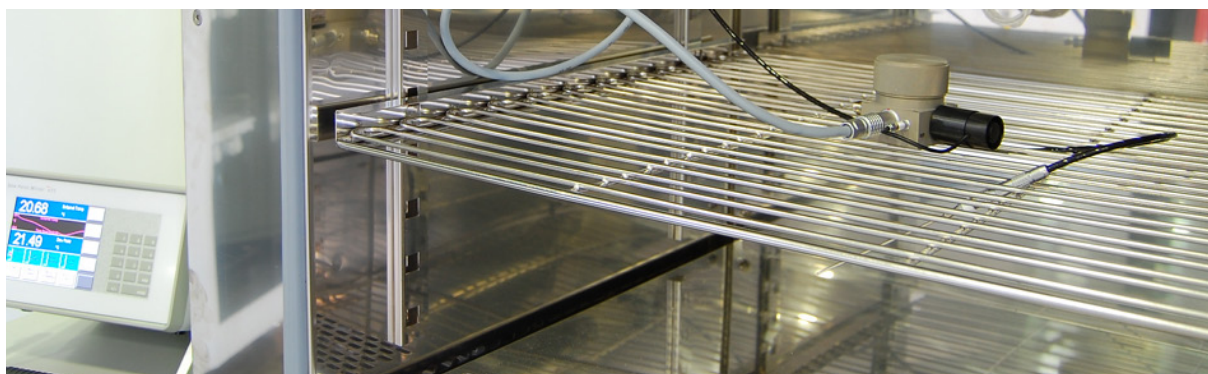



AVAILABLE MODELS	TEMPERATURE RANGE	HUMIDITY RANGE
TestaCal 300 ECP 20	-20°C to +180°C	10% to 98% RH
TestaCal 300 ECP 45	-45°C to +180°C	10% to 98% RH







## TEMPERATURE AND HUMIDITY CONTROL RANGES

### ● ● ● ● TESTACAL TESTING CHAMBERS

#### Performance in CLIMATIC testing range

TEMPERATURE RANGE		10°C to 95°C
TEMPERATURE UNIFORMITY <sup>(1a)</sup>		± 0,1°C to ± 1,0°C
TEMPERATURE STABILITY <sup>(1a)</sup>		± 0,1°C to ± 0,3°C
HUMIDITY RANGE		10% RH to 98% RH
HUMIDITY UNIFORMITY		± 0,3% RH to ± 2% RH
HUMIDITY STABILITY <sup>(1a)</sup>		± 0,15% RH to ± 1,5% RH

#### Performance in TEMPERATURE testing range

TEMPERATURE RANGE		-45°C or -20°C up to 180°C
TEMPERATURE UNIFORMITY <sup>(1a)</sup>		± 0,5°C to ± 1,5°C (1b)
TEMPERATURE STABILITY <sup>(1a)</sup>		± 0,1°C to ± 0,5°C (1b)
TEMPERATURE RATE OF CHANGE HEATING <sup>(2)</sup>		From 2,5°C to 4,5°C / minute
TEMPERATURE RATE OF CHANGE COOLING <sup>(2)</sup>		From 2°C to 4°C / minute

#### Other technical data

NOISE LEVEL		55 to 64 dBA
ELECTRICAL CONNECTION		3/N/PE AC 400V ± 10% 50Hz



Performances measured in factory with ambient temperatures between 20°C and 25°C

(1a) Measurements with empty chamber and no optional accessories; (1b) in temperature range up to 150°C;



(2) According to IEC/EN 60068-3-5. Values will vary with TESTA/TESTACAL model, internal volume, compressor type and condenser cooling system. Temperature rate of change can be adjusted to comply with the needed heating / cooling speed requirements. Optional accessories are available for more demanding heating and cooling temperature change rates.

## DIMENSIONS AND DRAWINGS

### ● ● ● ● TESTACAL 300

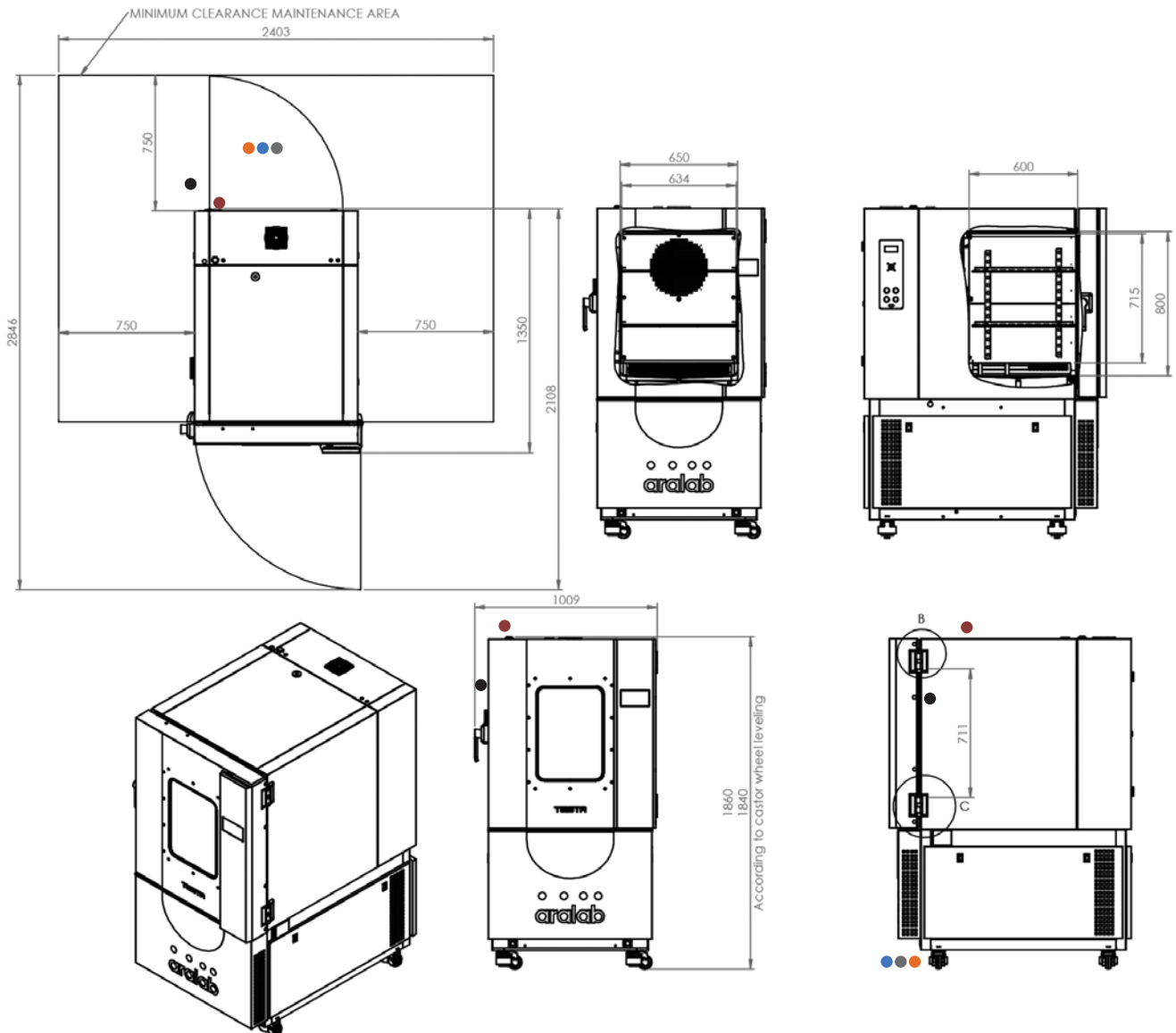

EXTERNAL DIMENSIONS (HxWxD) (mm)		1.830 x 980 x 1.340
INTERNAL DIMENSIONS (HxWxD) (mm)		800 x 650 x 600
INTERNAL NET VOLUME (LITERS)		272



- Standard refrigeration system is air cooled
- Services hub installation needs:
  -  1/2" demineralized water supply (for models with humidity control)
  -  50mm water drain at floor level
- Electrical cabinet installation needs:
 

**Supply power ECP20:**  
230VAC, 50Hz, 16A / Single Phase + Neutral + Ground  
Electrical protection: Circuit breaker 16A + N with 300mA differential  
Single Phase electrical cable RV-K 3G2,5 on the top

**Supply power ECP45:**  
400VAC, 50Hz, 16A / 3-Phase + Neutral + Ground  
Electrical protection: Circuit breaker 3 x 16A + N with 300mA differential  
3-Phase electrical cable RV-K 5G4 on the top

-  RJ45 (Ethernet) communications port
  -  Water Cooled option  
(standard TestaCal models are Air Cooled, but Water Cooled Condensers are also available):  
Water flow: up to 2000 l/hr (at 25 °C)  
Intake pressure: 2 to 5 bar  
Water entry and exit pipe: 1" or 28mm  
Differential pressure between entry and exit: ≥ 2,5 bars  
Maximum temperature of water entry: 26 °C  
Minimum temperature of water entry: 16 °C  
Recommended temperature of water entry: 18 °C

## EQUIPMENT DESCRIPTION

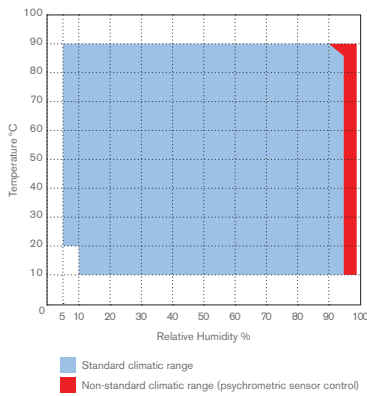

### TEMPERATURE

Control of temperature is done by the PLC Touch Screen "ClimaPlus", high tech PID / FUZZY temperature and humidity control, developed by Aralab.

#### TEMPERATURE SENSORS

- One (1) PT 100 Class A, located in air treatment tunnel
- One (1) PT 100 Class A, movable sensor for flexible placing inside chamber

#### HEATING

- By tubular stainless steel electric heaters located in the air treatment tunnel

#### COOLING

- By airtight mechanical Scroll compressor group with enforced ventilation and without CFC's.
- As an option the system can be cooled by an air / water condenser. Air is used by default and only in need of greater power is water used, thus increasing efficiency.

#### SECURITY

- Safety thermostat with High / Low temperature configuration, with automatic stop of all heating systems. Alarms programmed in the controller, with mute function. This function won't stop the chamber and it's only used to record the occurrence and to call the attention of the users with an audible alarm.

### HUMIDITY

Control of humidity levels is done by the PLC Touch Screen ClimaPlus V, high tech PID / FUZZY temperature and humidity control, and developed by Aralab.

#### HUMIDITY Sensors

- To measure and control humidity, Aralab has integrated 2 humidity measurement sensors: Psychrometric and Capacitive, simultaneously.

#### HUMIDITY / DRYING

- Humidity: Through thermostatic bath with dew point control.
- Drying: Through thermostatic bath with dew point control and additional dry coil

#### SECURITY

- Automatic stop function in case of water failure, with indication on the controller;
- Configurable High / Low Temperature alarms; High / Low humidity alarms.

### CONSTRUCTION



- Interior: AISI 304 hermetical welded, vapour tight, stainless steel
- Exterior: Zinc mild steel with epoxy coating finish (RAL 7035)
- Rock wool insulation
- Interior illumination by 12V halogen lamp (only available with optional window)
- Door: Double silicone joints and anti-condensation heating frames. Automatic electric locks with emergency opening from the inside
- 80 mm Ø side port for passing cables or other devices

### AIR FLOW / VENTILATION

- Forced through 1 ventilator/fan mounted at the top back end of the chamber.
- Air Renovation: By lateral port, also for compensating pressure



## COMMON ACCESSORIES

### PLEASE CONSULT ARALAB FOR OTHER ITEMS

---

FitoLog and FitoLogView Software pack

---

Anti-condensation observation window in multi layered glass

---

Water demineralizer

---

Water conductivity monitor

---

Additional entry side-ports

---

Calibration certificates from accredited external laboratory

---

Height leveling casters

---

Heating / Cooling temperature change rate speeds

---

Attachable computer for logging and chamber programs management

---

## WINDOW OPTION



The observation window is composed of a multilayered glass with optimum levels of thermal insulation. The interior and exterior glasses have a heating system that is activated in cold cycles and damp heat to prevent condensation at the surface.

## CONTROLLER

### CLIMA PLUS

Programmable PLC exclusively developed for ARALAB chambers

Easy to use coloured Touch-Screen Display Interface

Resolution of 0,1°C for Temperature and 0,1% for Relative Humidity

High performance temperature and humidity control with value correction in all ranges

Capability for creating 50 programs of 50 segments each

Internal non volatile memory for storing test data

Automatic restart of tests due to power failure, without losing data and restarting test where it was interrupted

Real-time monitoring of all functions and control of equipment.

Manage control settings via MODBUS/TCP

Possibility of programming a delay of the beginning of test

Monitoring and recording of all alarms

Possibility of performing events by external commands

Several outputs for connecting computers or other devices

Alarms management

Graphic representation of the tests and conditions

Remote access through VNC server

Possibility of running computer test programs and export them to the controller

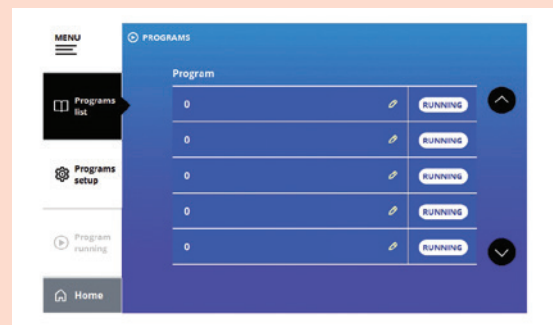
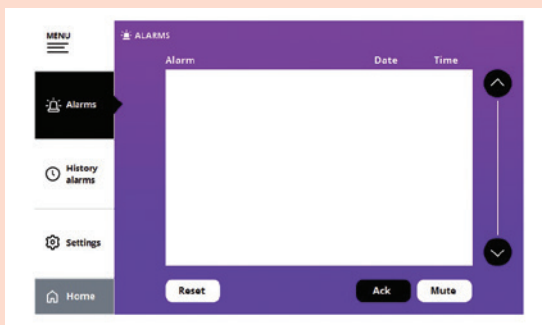
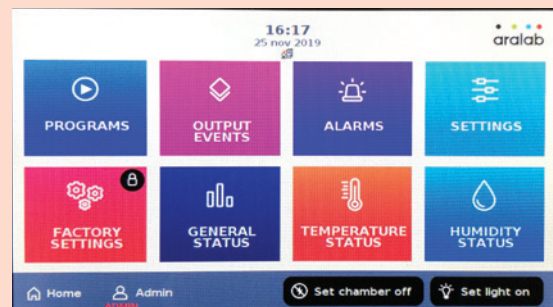
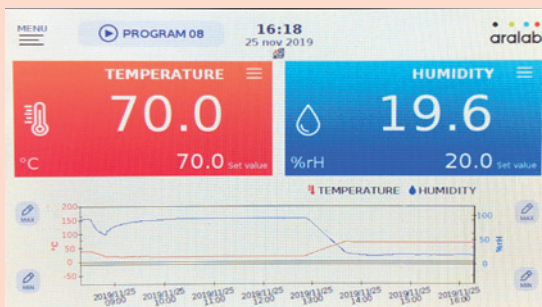

# FITOLOG SOFTWARE

The FitoLog software pack is a set of applications designed to facilitate the managing, monitoring and recording of programs and data from the FitoClima chambers. It consists of 3 applications: **FitoLog**, **FitoLogView** and **FitoProgram**.

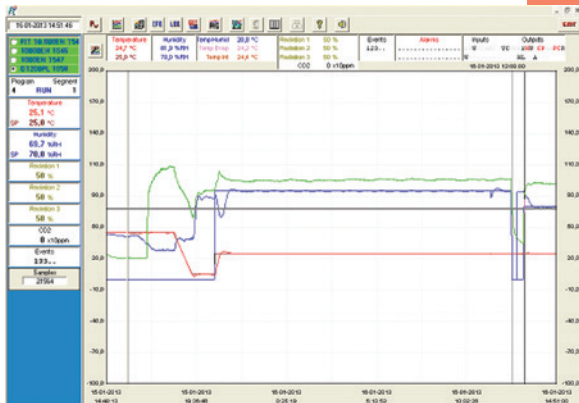

## FITOLOG

Records and displays in real time all data and details related to the set-points, running variables and equipment behaviour. It also retrieves information about the active components of the chamber, running processes, errors, alarms and allows the configuration of periodic or alarm triggered remote notifications (by email or SMS, depending on existing connections and accessories).

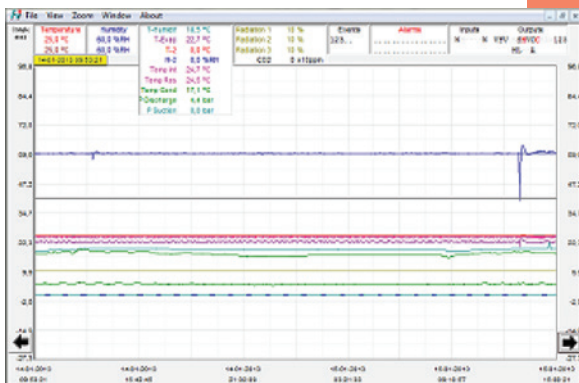

## FITOLOGVIEW

It is a working tool to process the data recorded by the FitoLog program. One can view, print and export the log contents to other file types, and analyse the data in other data management software (Excel, Star Office, Access or others).

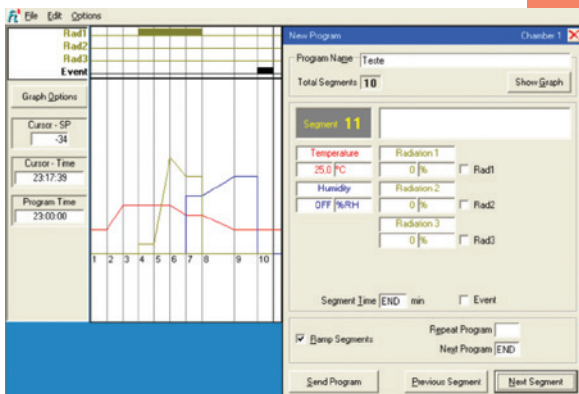

## FITOPROGRAM

This application simplifies the creation of programs and its integration on the chamber ClimaPlus controller. Up to 50 programs, each with 50 segments, can be designed and linked to create detailed environmental profiles and simulations.

### NOTIFICATIONS, FAST DIAGNOSTICS AND PROMPT TROUBLESHOOTING

With FitoLog it is possible to gather data from each of the chambers systems, which makes it a very useful tool to diagnose any necessary maintenance. This tool works as the "black box" of the equipment, giving Aralab technicians the necessary data to remotely carry out a fast and efficient diagnostic. All that is needed is a FitoLog file.



## INSTALLATION REQUIREMENTS

### INSTALLATION SITE

The place should be easily accessible, according to equipment dimensions and weight. It should have good air circulation and a room temperature between 10° and 26°C. The floor should be levelled and a minimum distance of 50cm from the walls and other equipment must be kept.

### ELECTRICAL SUPPLY

Near the equipment with connection for 3/N/PE AC 400V ± 10% 50Hz 16Amp.

The equipment is supplied with an ECE type power connector. The electrical panel must have a differential protection of 300 mA.

### WEIGHT

Approximately 450Kg

### HUMIDIFICATION CIRCUIT AND DEMINERALIZED WATER

The humidification circuit works exclusively with distilled or demineralized water. For this circuit, a water admission pressure of 1 to 6 bares and conductivity of ≤ 5µ Siemens is required.

### WATER CIRCUIT FOR COOLING CONDENSER (OPTIONAL FOR -45C AND -20C MODELS)

A cold water circuit is required for the cold system condenser. Technical characteristics:

- Water flow: 0 to 2000 liters/hour maximum
- Intake pressure: 3 to 6 bares
- Water entry and exit pipe: 1"
- Differential pressure between entry and exit: > 2,5 bares
- Maximum temperature of water entry: 26°C
- Adequate temperature of water entry: 18°C

### DRAIN

At floor level and near the equipment. The draining of the humidification and cooling systems water is done by gravity. For a correct draining there should be a minimum inclination of 10° in a descending trajectory from the chambers draining pipe until the sewage system.



Let's meet!  
[aralab@aralab.pt](mailto:aralab@aralab.pt)  
[www.aralab.pt](http://www.aralab.pt)  
T: +351 219 154 960



**Control the environment**  
Your own climate