



TESTING FITOTERM 150 CT2

ARALAB TEMPERATURE SHOCK TESTING CHAMBER WITH TWO
INDEPENDENT HOT/COLD CHAMBERS AND ELECTROMECHANICAL LIFT





ARALAB is a company specialized in designing, developing, manufacturing and servicing of high quality climatic chambers and controlled environment rooms.

Since 1985 we have been perfecting ways to create and control temperature, humidity, light, air flow and many other environmental conditions.

Only the highest quality components are used to manufacture our chambers so customers can have the best equipment for their research and testing purposes.

Control the environment, your own climate.



KEY FEATURES

- Simple and reliable functioning
- Two independent (Hot / Cold) testing areas connected by electromechanical lift
- Multifunctioning Hot and Cold testing zones can be used independently
- Energy saving technology, temporarily cutting of the Hot or Cold zones when not in use during cycles
- Nonpolluting construction and cooling system
- Equipped with digital touch-screen CLIMAPLUS V controller
- Reduced investment, low maintenance, reliable and accurate performance
- Compliant with international standards and requirements EN, IEC, DIN, ISO, NP and UNE



Certified ISO:9001 for its Quality Management System

EQUIPMENT DESCRIPTION









The temperature shock test chamber FitoTerm 150CTE2, features two independent chambers on the same chassis, with the upper (Hot) chamber - heated by electric heaters and air circulation - reaching uniform temperatures of 200°C; and the lower (Cold) chamber - with dynamic ventilation +/- 2m/s for homogenization and temperature uniformity - reaching cold temperatures down to -75°C.

The temperature shock test is carried out by transferring the test specimens between the two chambers through an electro-mechanical lift, with +/- 5 seconds of transfer time. Aralab's evolution of the mechanical lifting system made possible to eliminate all vibrations on the lifting cradle, making a smooth up and down movement while performing the tests.



TECHNICAL SPECIFICATIONS

● ● ● ● FITOTERM 150 CTE2

TEMPERATURE (HOT CHAMBER)		Ambient to +200°C
TEMPERATURE (COLD CHAMBER)		-75° C to +60° C
TRANSFER TIME BETWEEN CHAMBERS		≤ 5 seconds
TEST SPACE DIMENSIONS (H X W X D)		410 mm x 470 mm x 650 mm
CRADLE WEIGHT LOAD		50 Kg
TEMPERATURE PRECISION IN TIME		≤ ± 0,5°C
TEMPERATURE PRECISION IN SPACE		≤ ± 1,0°C
WEIGHT IN KG		900 Kg
ELECTRICAL SUPPLY		3PH, N/PE, 400V, 32Amp

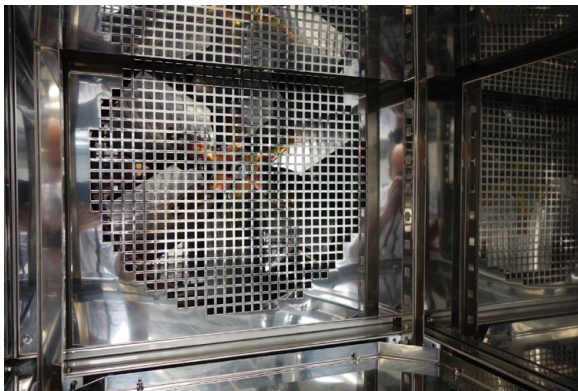

DIMENSIONS AND DRAWINGS

● ● ● ● FITOTERM / FITOCLIMA 8.000

EXTERNAL DIMENSIONS (HxWxD) (mm)		2.180 x 950 x 1.910
INTERNAL DIMENSIONS (HxWxD) (mm)		410 x 470 x 650

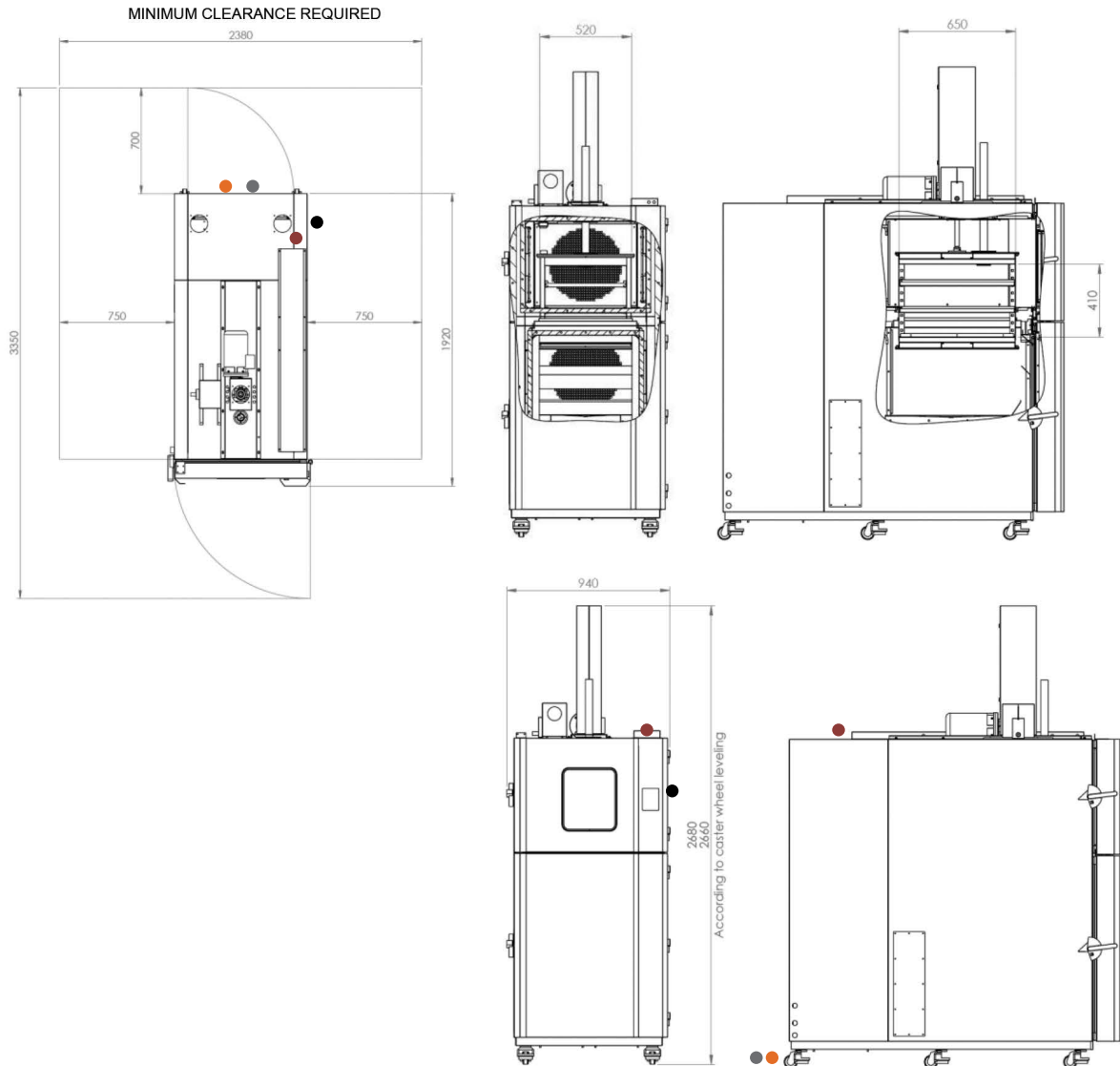

- Services hub installation needs:**
 - 50mm water drain at floor level
- Electrical cabinet installation needs:**

Supply power:
400VAC, 50Hz, 32A / 3-Phase + Neutral + Ground
Electrical protection: Circuit breaker 3 x 32A + N with 300mA differential
3-Phase electrical cable RV-K 5G6 on the top

 - **RJ45 Ethernet socket communication port**
- Water cooled
Water flow: up to 2000 litres/hour (at 25 °C)
Intake pressure: 2 to 5 bar
Water entry and exit pipe: 1" or 28mm
Differential pressure between entry and exit: $\geq 2,5$ bars
Maximum temperature of water entry: 26 °C
Minimum temperature of water entry: 16 °C
Recommended temperature of water entry: 18 °C

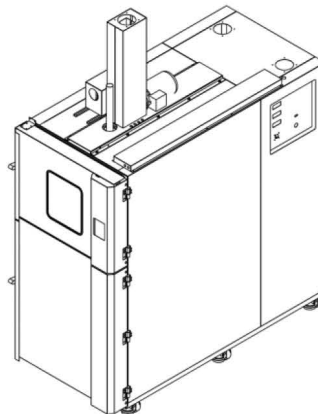

EQUIPMENT DESCRIPTION

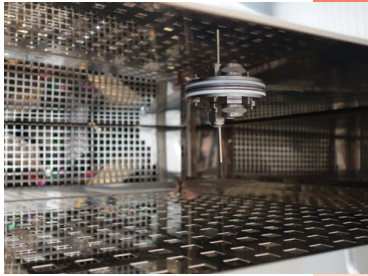

TEMPERATURE

TEMPERATURE CONTROL

Temperature control is made by the PLC Touch Screen ClimaPlus V controller, developed by Aralab and exclusively for its environmental test chambers.

TEMPERATURE SENSORS

- PT 100 DIN Class A, located in the air treatment tunnels. One in each chamber
- PT 100 DIN Class A, mobile sensor

HEATING

- Heating is achieved by tubular stainless steel electric heaters located in the air treatment tunnel. Temperature is attained by a dynamic ventilator at ± 2 m/s with programmed interruptions during the upwards and downward movements of the lift.

COOLING

- Cooling is achieved without use of CFC's, by a hermetically sealed Scroll compressor (with low noise levels with great cooling efficiency) and also by water cooled refrigeration system. Temperature uniformity is attained by a dynamic ventilator at ± 2 m/s with programmed interruptions during the upwards and downward movements of the lift.

THERMAL SECURITY

- Safety thermostat with High / Low temperature configuration controlled by independent thermostats with integrated alarms.

TRANSFER BETWEEN HOT AND COLD CHAMBERS

- Transmission through ball spindle drive to eliminate vibrations and system deceleration when reaching up / down positions
- The commutation between cabinets is done through an electromechanical elevator, with a transference time of +/- 5 seconds
- Security stopping and blockage of the elevator when opening the doors
- Bright indicator of elevator position and cycle:
 - Green - heat cabinet
 - White - cool cabinet
 - Intermittent - to stabilize the Set Point
 - Red - indicating an alarm



CONSTRUCTION

- Interior: AISI 304 stainless steel. Hermetical "Vapor-Proof" cabinets
- Exterior: Zinc mild steel with epoxy coating finish
- Window: Observation window in multiple layer glass (only in heating chamber)
- Thermal isolation: Rock wool
- Interior illumination: 12V halogen (only in the heat cabinet)
- Doors: Total opening with lock, double silicone joints and heating to prevent condensation





SECURITY

- Level 1 – High / Low individual thermostats with audible alarm
- Level 2 – Intermittent audible alarm for deviation of selected the band limits

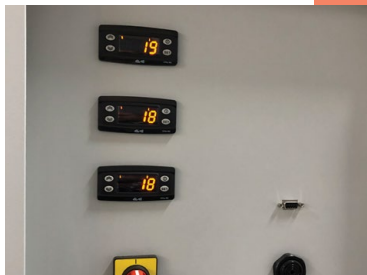

CUT-OFF PANEL, SECURITY AND COMMUNICATIONS

Mounted on left lateral panel of chamber and equipped with:

- Security thermostat
- Mains switch
- Audible alarms
- RS232 connection

COMMAND PANEL

- At the front door with Touch Screen Programmable Controller Climaplus V with 120 mm x 90 mm



INCLUSIONS

- 1 stainless steel shelf
- 1 entry port at the top of the chamber
- 6 casters with adjustable height
- Observation window in multi-layer anti-condensation glass
- Instructions manual in English
- 2 years warranty

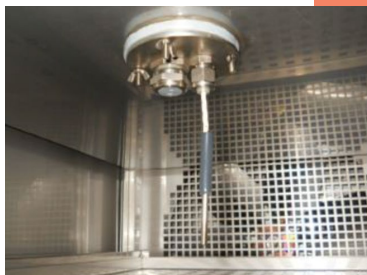

OPTIONAL ACCESSORIES

- Cool-UP (option to cool the heat cabinet with fresh air)
- FitoLog, FitoView and FitoProgram Software pack
- RS232 cable
- Additional shelves
- Calibration Certificate from Accredited Laboratory

CONTROLLER

CLIMA PLUS V

Programmable PLC ClimaPlus V, exclusively developed for Aralab chambers

Programmable, easy to use controller with Touch Screen Display (168 x 112mm)

Resolution of 0.1°C for Temperature and 0.1% for Relative Humidity

Capability for configuring 50 test programs of 50 segments each

Non-volatile memory

Automatic restart of test due to electric power failure, without losing data and where it was interrupted

Configuration, monitoring and recording of all alarms

Possibility of performing events by external commands

RS232 output for connecting computers

Graphical visualization of the test parameters on the controller

Possibility of running test programs on the computer and exporting them to the controller

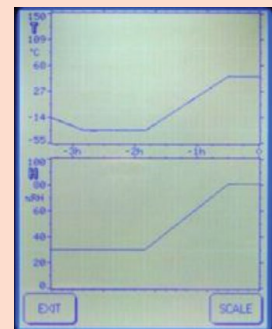
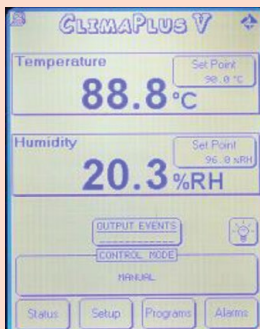

FITOLOG SOFTWARE

The FitoLog software is a set of applications designed to monitor and register data from the chambers processes variables. The software consists of 3 applications: **FitoLog**, **FitoLogView** and **FitoProgram**.

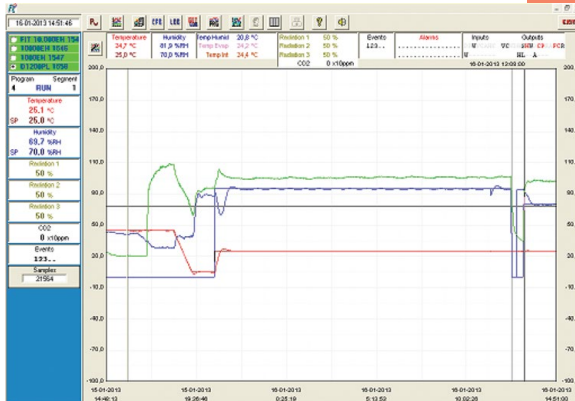

FITOLOG

Displays and records in real time all the data and details of the measurements and respective set-points in a file. It also retrieves the data of process variables, errors, alarms and allows external alerts configuration, which may include Email or SMS to report the condition of the equipment or warnings of alarms.

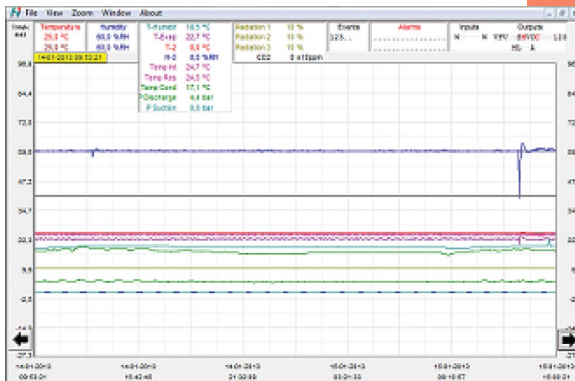

FITOLOGVIEW

It is a working tool to process the data acquired by FitoLog. You can view, print and export to other file types, and analyze the data in other programs (Excel, Access or others).

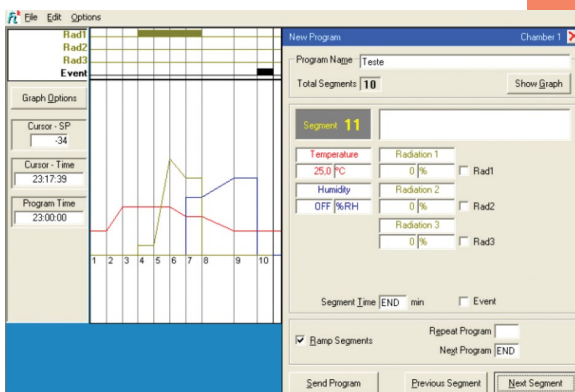

FITOPROGRAM

This application allows the designing of test programs and its integration on the chamber controller.

INSTALLATION REQUIREMENTS

To ensure a correct functioning of the chamber, the following installation conditions are required:

INSTALLATION SITE

The place should be easily accessible, according to equipment dimensions and weight. It should have good air circulation and a room temperature between 10° and 26°C. The floor should be leveled and a minimum distance of 50cm from the walls of other equipment must be kept.

ELECTRICAL SUPPLY

3PH, N/PE, 400V, 32Amp

WATER CIRCUIT FOR COOLING CONDENSER

A cold water circuit is required for the cold system condenser. Technical characteristics:

- Water flow: up to 2000 liters/hour (at 25°C)
- Intake pressure: 2 to 5 bar
- Water entry and exit pipe: 1" or 28mm
- Differential pressure between entry and exit: > 2,5 bars
- Maximum temperature of water entry: 26°C
- Minimum temperature of water entry: 16°C
- Recommended temperature of water entry: 18°C

DRAIN

At floor level and near the equipment. The draining of the humidification and cooling systems water is done by gravity. For a correct draining there should be a minimum inclination of 10° in a descending trajectory from the chambers draining pipe until the sewage system.

Features and specifications are subject to change. Aralab continuously studies ways to further develop its products to achieve better performances and overall product quality. As a result, characteristics and specifications provided in this document may be subject to changes.

Let's meet!
aralab@aralab.pt
www.aralab.pt
T: +351 219 154 960



Control the environment
Your own climate

